

YUEQING HONGYI ELECTRONICS CO., LTD
乐清市宏一电子有限公司

SPECIFICATION FOR APPROVAL

承认书

CUSTOMER 客户名称	
DESCRIPRION 产品名称	GH1.25 系列连接器
ITEM NO 编 号	HY-A12509 (A22)
DATE 日 期	2022-8-30

CUSTOMER ACKNOWLEDGEMENT SEAL

客户承认印签

(APPROVAL) 核准	(ENGINEERING) 工程	(PURCHASE) 采购	(QUALITY) 品质
承认结果: <input type="checkbox"/> 通过 <input type="checkbox"/> 不通过 <input type="checkbox"/> 重新送样			

IS09001

IS014001

IS045001

IATF16949 体系认证

ADD: No. 30, Wenjing Road, Houyu village, Shifan street, Yueqing City, Zhejiang Province

地址: 浙江省乐清市石帆街道后屿文景路 30 号

TEL:0577-62380521

FAX: 0577-62381979 P.C:325608

http: //www.zhehongyi.com

E-MAIL:yaohongxiao88@126.com

产 品 承 认 书 目 录

1、封面	1-1
2、修订履历	2-2
2、目录	3-3
3、技术规范	4-10
4、产品图纸	11-17

PRODUCT SPECIFICATION

产品规范

1、Scope

适用范围

This specification includes the following specifications, including the specification of GH1.25 series connector

本规范包括下列此种规格包括 GH1.25 系列连接器规格说明

2、Appearance and Dimension

外观及尺寸

2.1 Appearance: Product surface without defect、dirt、crack、and mechanical damage, Contact without rust, plating not oxidized and not peeled.

产品表面不应有对制品有害的缺陷、污垢、裂痕及机械损伤；接触件无锈蚀、镀层氧化脱落等现象

2.2 Dimension: According to drawings

外形尺寸：依照附图

3、Disposal of Material and surface

材料与表面处理

Specification 规格内容	Material 材质	Finish 表面处理	Environmental protection grade 环保等级
Terminal 端子	Phosphor bronze 锡青磷铜 厚 0.12mm	Tin Plating: 2.5~5 μm 镀锡: 2.5~5 μm	RoHS2.0
Housing 胶壳	PA66 UL94V-0	Color: White 颜色: 白色	
Wafer 卧贴针座	Plastic 塑壳	PA6T/LCP UL94V-0 颜色: 米色	
	Contact 插针	Phosphor bronze 锡青磷铜 厚 0.20mm 镀锡: 2.5~5 μm	
	Solder tab 焊护耳	Phosphor bronze 锡青磷铜 厚 0.20mm 镀锡: 2.5~5 μm	
Wafer 立贴针座	Plastic 塑壳	PA6T/LCP UL94V-0 颜色: 米色	
	Contact 插针	Phosphor bronze 锡青磷铜 厚 0.20mm 镀锡: 2.5~5 μm	
	Solder tab 焊护耳	Phosphor bronze 锡青磷铜 厚 0.20mm 镀锡: 2.5~5 μm	

4、Ratings and applicable wires

额定等级

Item 项目	Standard 规格
Rated Voltage 额定电压	50V AC/DC
Rated Current 额定电流	1A AC/DC
Ambient temperature Range 使用温度范围	-25°C- +85°C
Applicable wire insulation 适用线径	AWG26#-32#

5、Electrical Performance

电气性能

N0. 序号	Ltem 项目	Test mode 试验方法	Requirement 技术要求
5.1	ContactResistance 接触电阻	Male female cooperation, open voltage less than 20mV, current 100mA detection connector at both ends 公母配合, 开放电压20mV 以下, 电流100mA 检测连接器连接器两端	Initial:20mΩ Max 初始: 20mΩ Max After Test: 30mΩ Max 试验后: 30mΩ Max
5.2	withstandvoltage 耐电压	Mate connectors, apply 500V AC for 1 minute between adjacent terminal or ground 公母配合, 在相邻端子, 端子与地片之间, 使用500V 的交流电1 分钟, 检测连接器	No Breakdown and Flashover 外观无损伤, 无打火花
5.3	InsulationResistance 绝缘电阻	Mate connectors, apply 500V DC between adjacent terminal or ground 公母配合, 在相邻端子, 端子与地片之间, 使用500V 的直流电, 检测连接器	100MΩ Min

6、机械性能

Mechanical Performance

NO. 序号	Ltem 项目	Test mode 试验方法	Requirement 技术要求								
6.1	Terminal crimping wire strength 端子压接导线强度	Fix the crimped terminal, apply axial pull out force on thewire 固定铆线后的端子, 使电线与端 子分离时所需的最小力量	<table border="1"> <tr> <td data-bbox="938 315 1141 461">AWG#26 wire AWG#26导线</td> <td data-bbox="1141 315 1465 461">More than 20N ≥20N</td> </tr> <tr> <td data-bbox="938 461 1141 607">AWG#28 wire AWG#28导线</td> <td data-bbox="1141 461 1465 607">More than 13N ≥13N</td> </tr> <tr> <td data-bbox="938 607 1141 752">AWG#30 wire AWG#30导线</td> <td data-bbox="1141 607 1465 752">More than 8N ≥8N</td> </tr> <tr> <td data-bbox="938 752 1141 896">AWG#32 wire AWG#32导线</td> <td data-bbox="1141 752 1465 896">More than 6N ≥6N</td> </tr> </table>	AWG#26 wire AWG#26导线	More than 20N ≥20N	AWG#28 wire AWG#28导线	More than 13N ≥13N	AWG#30 wire AWG#30导线	More than 8N ≥8N	AWG#32 wire AWG#32导线	More than 6N ≥6N
AWG#26 wire AWG#26导线	More than 20N ≥20N										
AWG#28 wire AWG#28导线	More than 13N ≥13N										
AWG#30 wire AWG#30导线	More than 8N ≥8N										
AWG#32 wire AWG#32导线	More than 6N ≥6N										
6.2	Terminal/ Housing Retention Force 端子保持力	Apply axial pull out force at the speed rate of 25.4±3mm/minute on the terminal assembled in the Housing 以每分 25.4±3mm 的速率, 将端子从 Housing 内轴 向拔出	Per contact: 8N Min 单一接触点: 8N Min								
6.3	Insertion & withdraw Force 插拔力	Insert and withdraw Connectors at the speed rate of 25.4±3mm/minute 以每分 25.4±3mm 的速率插入和拔出	Refer to paragraph 8 参照第 8 项								
6.4	Pin Retention Force Pin 针保持力	Apply axial push force at the speed rate of 25.4±3mm/minute 以每分 25.4±3mm 的速率, 将 PIN 针从 Wafer 内轴向拔出	Per contact: 3N Min 单一接触点: 3N Min								

7、Endurance Characteristics:

环境性能

NO. 序号	Ltem 项目	Test mode 试验方法	Requirement 技术要求	
7.1	Repeated Insertion/ Withdrawal 重复插拔	When mated up to 30 cycles repeatedly by the rate of 10 cycles per minute 以每分钟不超过 10 次的速率, 将公母插拔 30 次	Contact Resistance 接触电阻	30 mΩ Max
7.2	Temperature Rise 温升测试	Mating connectors shall be energized at rating current until thermal stability is achieved, and then measured the temperature rise 公母连接器配合后, 加载额定电流直到温度上升到稳定 状态, 然后再测量温升	Temperature Rise 温升测试	30℃ Max
7.3	Vibration test 振动测试	Amplitude: 1.5mm P-P Sweep time: 10~55~10 HZ in 1 minute Duration: 2 hours in each X. Y. Z axials 振幅: 1.5mm P-P 时间: 10~55~10 HZ in 1 minute 持续时间: 每轴向 2 小时	Appearance 外观	No damage 无异常
			Contact Resistance 接触电阻	30 mΩ Max
			Discontinuity 瞬断	1 micro-second Max.
7.4	Heat Resistance 耐热性	85±2℃,96 hours	Appearance 外观	No damage 无异常
			Contact Resistance 接触电阻	30 mΩ Max
7.5	Cold Resistance 耐寒性	-25±3℃,96 hours	Appearance 外观	No damage 无异常
			Contact Resistance 接触电阻	30 mΩ Max
7.6	Humidity 耐湿性	Temperature: 60±2℃ Relative Humidity: 90~95% Duration: 96 hours 温度: 60±2℃ 湿度: 90~95%(RH) 持续时间: 96 hours	Appearance 外观	No damage 无异常
			Contact Resistance 接触电阻	30 mΩ Max
			Withstand Voltage 耐电压	No Breakdown and Flashover 外观无损伤, 无打火花
			Insulation Resistance 绝缘电阻	100MΩ Min

NO. 序号	Ltem 项目	Test mode 试验方法	Requirement 技术要求	
7.7	温度变化 Temperature Cycling	5 cycles of: a) -25°C 30 minutes b) +85°C 30 minutes	Appearance 外观	No damage 无异常
		从-25°C持续30 分钟升至+85°C持续30 分钟, 循环5 次	Contact Resistance 接触电阻	30 mΩ Max
7.8	Salt spray 盐雾	24±1 hours exposure to a salt spray from the 5±1% solution at 35±2°C	Appearance 外观	No damage 无异常
		在温度35±2°C, 盐水浓度5±1%下, 盐水 喷雾24±1 小时	Contact Resistance 接触电阻	30 mΩ Max
7.9	Solderability 焊锡附着性	Soldering Time: 3-5sec solder Temperature: 245±5°C 焊接时间: 3-5 秒 焊接温度: 245±5°C	Solder Wetting 焊料润湿	Immersion area above 95% 浸渍面积 95% 以上
7.10	Solder- Resistance 焊锡耐热性	SMT reflow soldering heat resistance range: Soldering time:5~10sec solder. Temperature:255±5°C SMT 型回流焊接耐热范围: 焊接时间: 5~10 秒. 焊接温度: 255±5°C Please refer to the 9.1 solder reflow temperature curve 回流焊请参考 9.1 温度曲线图	Appearance 外观	No damage 无异常

8、INSERTION/WITHDRAWAL FORCE

综合插入力及拔出力

No. of CTK PIN 数	At Initial 初始值		At 30th 插拔 30 次	No. of CTK PIN 数	At Initial 初始值		At 30th 插拔 30 次
	I. F (N Max) 插入力	W. F (N Min) 拔出力	W. F (N Min) 拔出力		I. F (N Max) 插入力	W. F (N Min) 拔出力	W. F (N Min) 拔出力
2	17	1.5	0.5	12	27	6.5	5.5
3	18	2.0	1.0	13	28	7.0	6.0
4	19	2.5	1.5	14	29	7.5	6.5
5	20	3.0	2.0	15	30	8.0	7.0
6	21	3.5	2.5				
7	22	4.0	3.0				
8	23	4.5	3.5				
9	24	5.0	4.0				
10	25	5.5	4.5				
11	26	6.0	5.0				

9、 SMT lead-free process temperature curve SMT 无铅工艺温度曲线

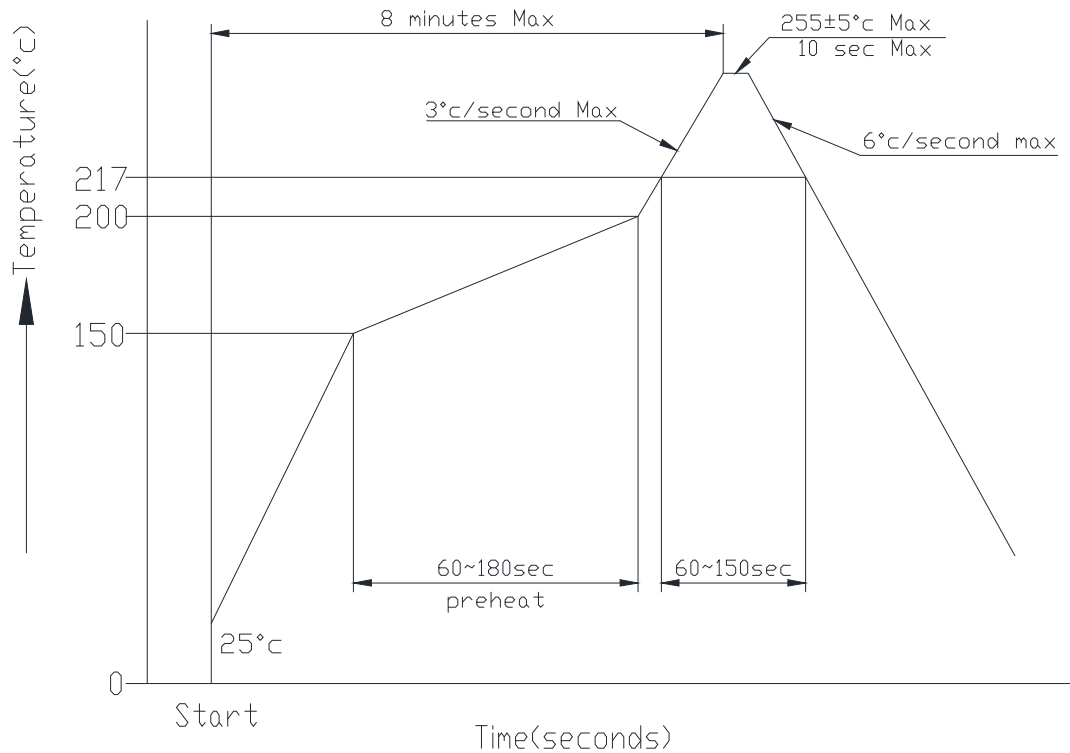

Notes: Please check the reflow soldering condition by your own devices beforehand. Because the condition changes by the soldering devices, P.C. boards, and so on

注记: 由于 P.C 板等焊接装置改变条件,所以请预先用自己的装置检查回流焊的条件

10、 Caution 注意事项

plastic because of characteristics with water after package is opened should avoid exposure to, the temperature is higher than 30 °C, humidity is higher than 60%RH in the environment, and in the 24 hours after all after use, to prevent subsequent reflow, wave soldering process to produce foaming phenomenon of deformation

塑料因具有吸水之特性包装拆封后应避免暴露于, 温度高于 30°C, 湿度高于 60%RH 的环境中, 并在拆封后 24 小时内全数使用完毕, 防止后续回流焊、波峰焊制程产生起泡变形现象

REV.	日期	ECN NO.	变更内容	制图
DATE	DATE	DESCRIPTION	DESCRIPTION	DRAWN

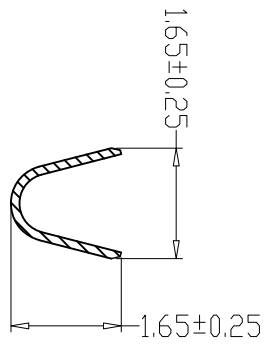
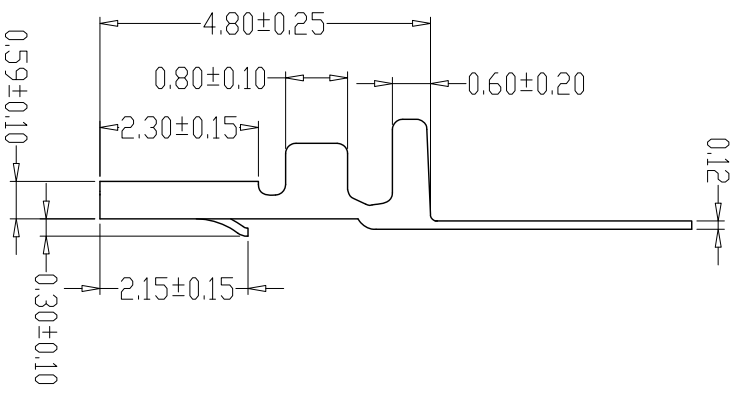
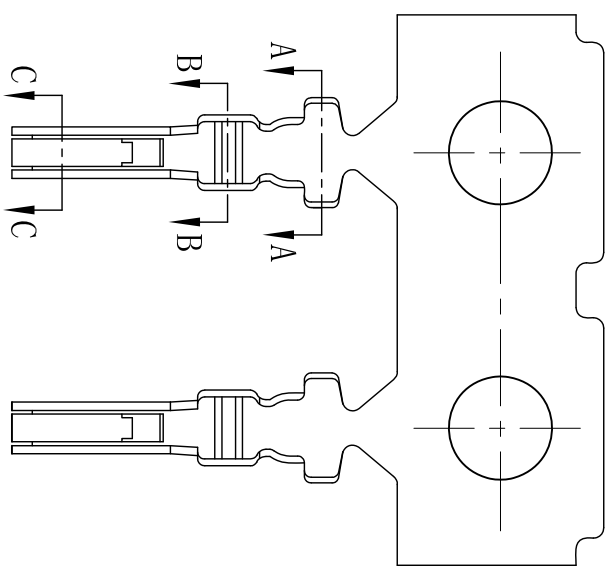

SEC: A-A

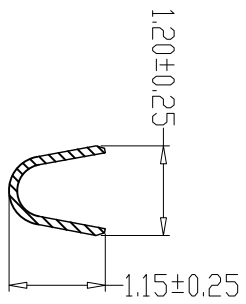

SEC: B-B

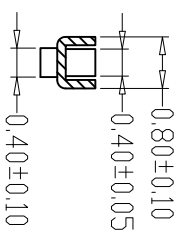

SEC: C-C

SPECIFICATIONS

- 1、Current Rating: 1A AC, DC
- 2、Voltage Rating: 50V AC, DC
- 3、Temperature Range: -25°C~+85°C
- 4、Contact Resistance: 20mΩ Max
- 5、Insulation Resistance: 100MΩ Min
- 6、Withstanding Voltage: 500V AC/minute
- 7、Material: Phosphoric bronze Tin-plated
- 8、Applicable Wire Sizes: AWG#26~32#

GENERAL TOLERANCE		制图		料号		版本	
X.X±0.25	X.±2°	DRAWING	张迎春	PART NO.	A12509-T	REV.	A
X.XXX±0.10		CHECK	钱岳生	TITLE	GH1.25端子	页次	1/1
X.XX±0.20		APPROVAL	张名	CITM. NO.		SHEET	
		UNIT	2022.08.30	比例	1:1		
		SCALE		Yueqing Hongyi Electronics Co., Ltd			

版本 REV.	日期 DATE	ECN NO.	变更内容 DESCRIPTION	制图 DRAWN

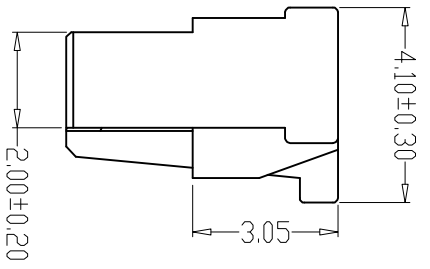
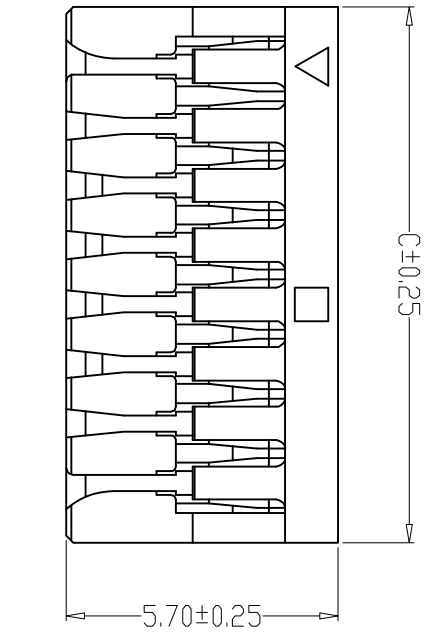
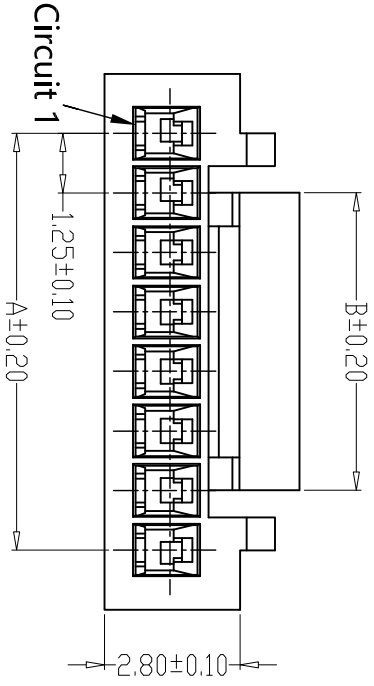
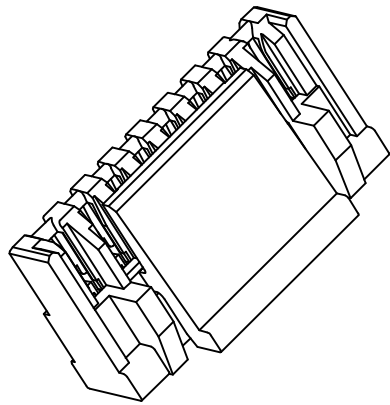

SPECIFICATIONS

- 1、Current Rating: 1A AC, DC
- 2、Voltage Rating: 50V AC, DC
- 3、Temperature Range: -25°C~+85°C
- 4、Contact Resistance: 20mΩ Max
- 5、Insulation Resistance: 100MΩ Min
- 6、Withstanding Voltage: 500V AC/minute
- 7、Material: PA66, UL94V-0

PIN	尺寸 (mm)		
	A	B	C
-02Y	1.25	2.00	3.75
-03Y	2.50	3.20	5.00
-04Y	3.75	4.25	6.25
-05Y	5.00	4.25	7.50
-06Y	6.25	6.25	8.75
-07Y	7.50	6.25	10.00
-08Y	8.75	6.25	11.25
-09Y	10.00	6.25	12.50
-10Y	11.25	8.20	13.75
-11Y	12.50	8.20	15.00
-12Y	13.75	8.20	16.25
-13Y	15.00	8.20	17.50
-14Y	16.25	8.20	18.75
-15Y	17.50	8.20	20.00

GENERAL TOLERANCE		张迎春		料号	
X.X±0.25	X.±2°	DRAWING	2022-08-29	A12509-nY	
X.XXX±0.10		CHECK	钱岳生	品名	
X.XX±0.20		APPROVAL	2022-08-29	GH1.25孔座	
		单位	张名	客户料号	
		MM	2022-08-30	CITM.NO.	
		SCALE	1:1	版本	
				A	

乐清市宏一电子有限公司
Yueqing HongYi Electronics Co., Ltd

胶壳各P位结构示意图

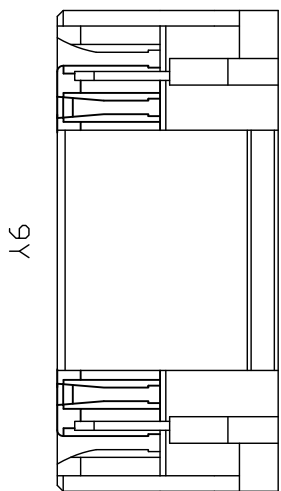
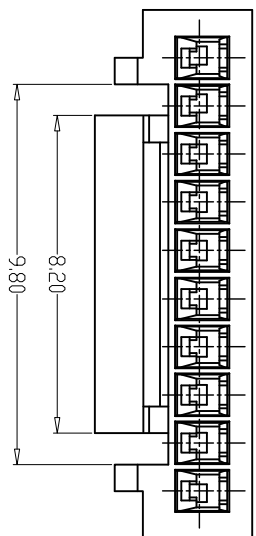
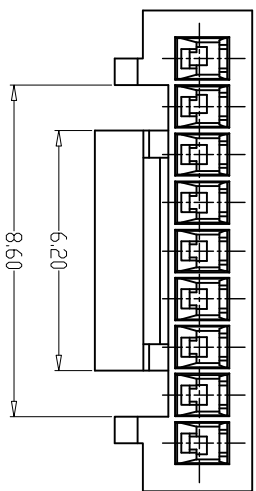
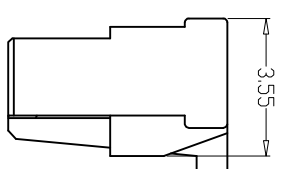
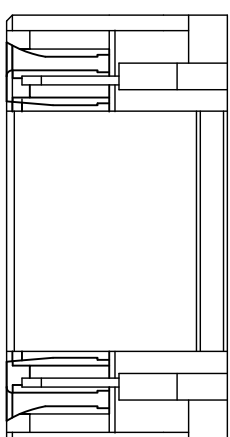
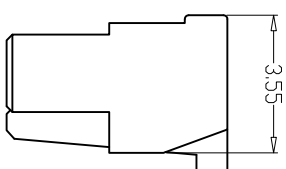
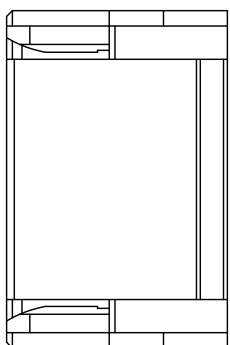
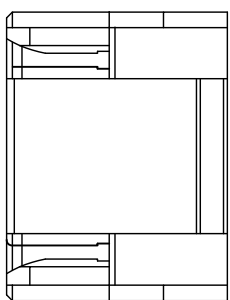
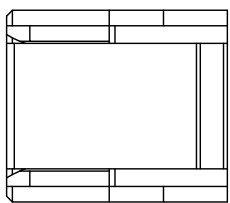
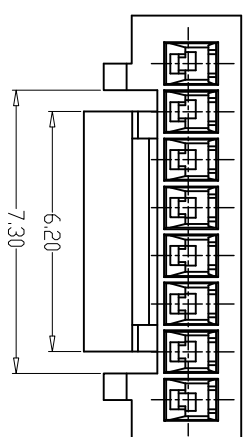
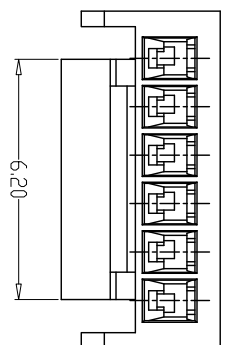
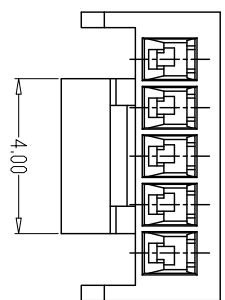
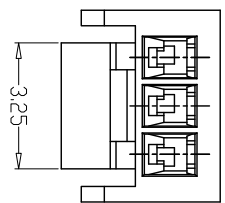
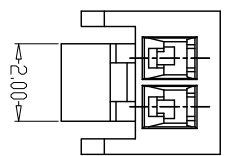

版本 REV.	日期 DATE	ECN NO.	变更内容 DESCRIPTION	制图 DRAWN
------------	------------	---------	---------------------	-------------

- 2Y
- 3Y
- 4-5Y
- 6-7Y
- 7Y以下
- 8Y
- 8Y以上

GENERAL TOLERANCE		制图		料号		版本	
X.X±0.25	X.±2°	DRAWING	张迎春	PART NO.	12508-nY	REV.	A
X.XXX±0.10		CHECK	钱岳生	TITLE	CHI. 25孔座	页次	2/2
X.XX±0.20		APPROVAL	张名	客户料号		SHEET	
		UNIT	2022. 08、30	CITM. NO.			
		SCALE	1:1				

乐清市宏一电子有限公司
Yueqing HongYi Electronics Co., Ltd

版本	日期	ECN NO.	变更内容	制图
REV.	DATE		DESCRIPTION	DRAWN

SPECIFICATIONS

- 1、Current Rating: 1A AC, DC
 - 2、Voltage Rating: 50V AC, DC
 - 3、Temperature Range: -25°C~+85°C
 - 4、Contact Resistance: 20mΩ Max
 - 5、Insulation Resistance: 100MΩ Min
 - 6、Withstanding Voltage: 500V AC/minute
 - 7、Material: Wafer PA6T/LCP, UL94V-0
- PIN Phosphoric bronze Tin-plated
Solder tad Phosphoric bronze Tin-plated

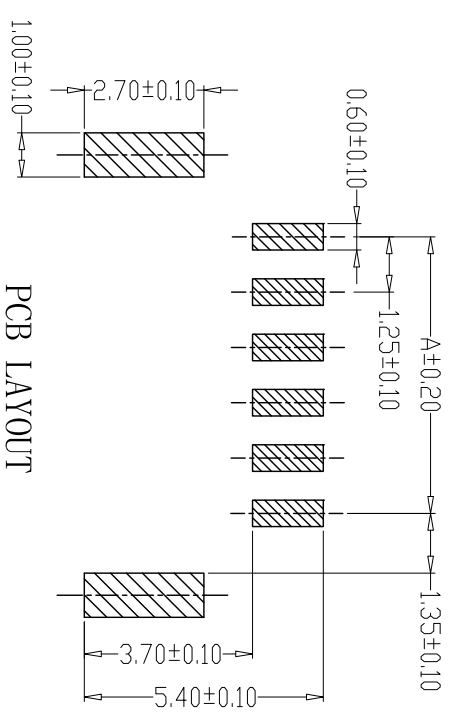
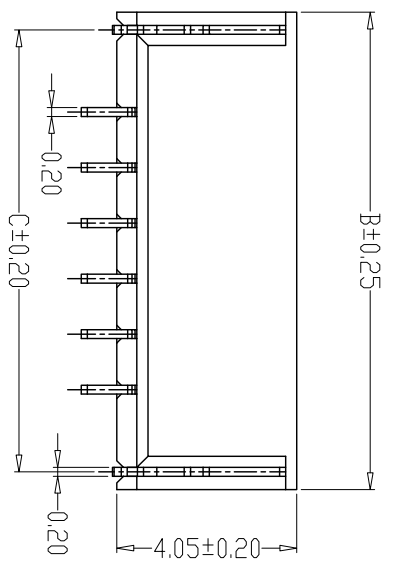
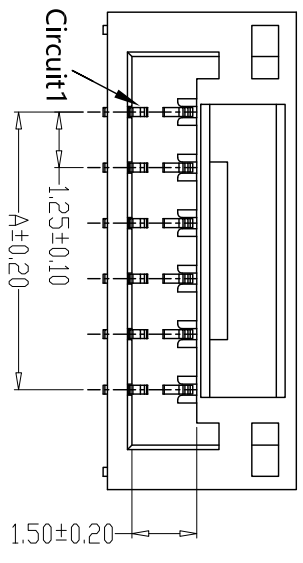

PCB LAYOUT

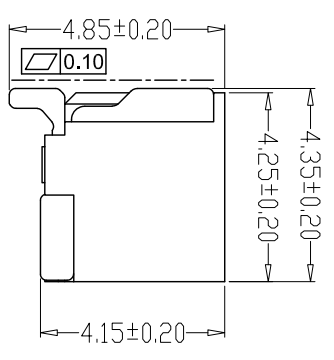

PIN	尺寸 (mm)		
	A	B	C
-02AWB	1.25	5.75	4.95
-03AWB	2.50	7.00	6.20
-04AWB	3.75	8.25	7.45
-05AWB	5.00	9.50	8.70
-06AWB	6.25	10.75	9.95
-07AWB	7.50	12.00	11.20
-08AWB	8.75	13.25	12.45
-09AWB	10.00	14.50	13.70
-10AWB	11.25	15.75	14.95
-11AWB	12.50	17.00	16.20
-12AWB	13.75	18.25	17.45
-13AWB	15.00	19.50	18.70
-14AWB	16.25	20.75	19.95
-15AWB	17.50	22.00	21.20

GENERAL TOLERANCE		制 图		料号	
X.X±0.25	X.±2°	DRAWING	张迎春	A12509-nAWB	版本
X.XXX±0.10		CHECK	钱岳生	GHI, 25脚贴片	REV.
X.XX±0.20		APPROVAL	张名	WAFER SMT TYPE	A
		UNIT	张名	CITM. NO.	页次
		MM	2022.08.30		1/2
		SCALE	1:1		

乐清市宏一电子有限公司
Yueqing Hongyi Electronics Co., Ltd

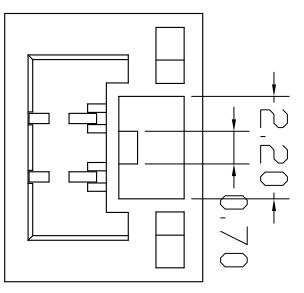

2A

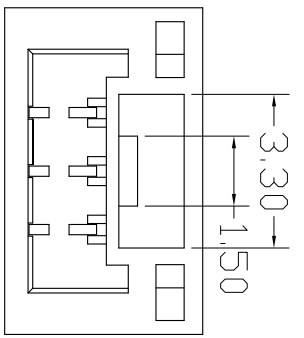

3A

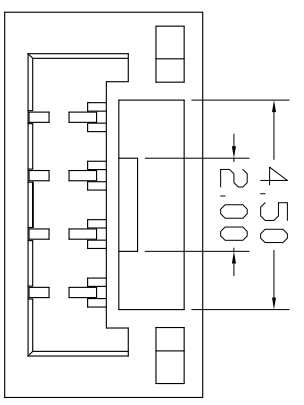

4A

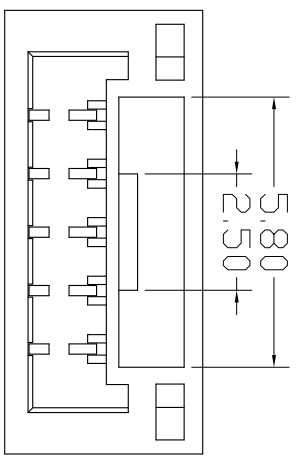

5A

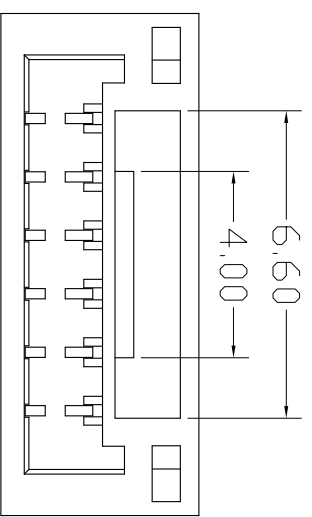

6A

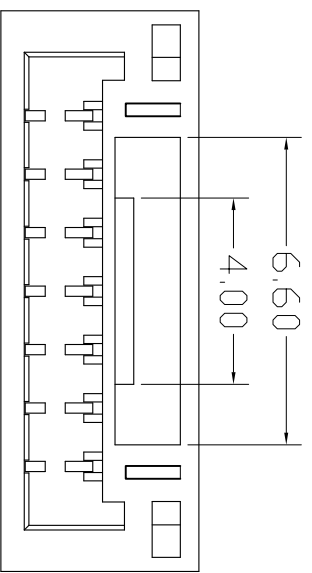

7A

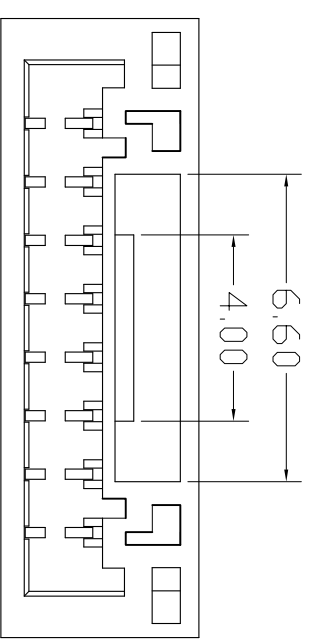

8A

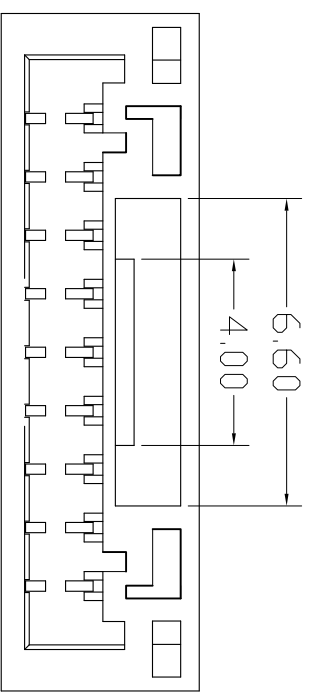

9A

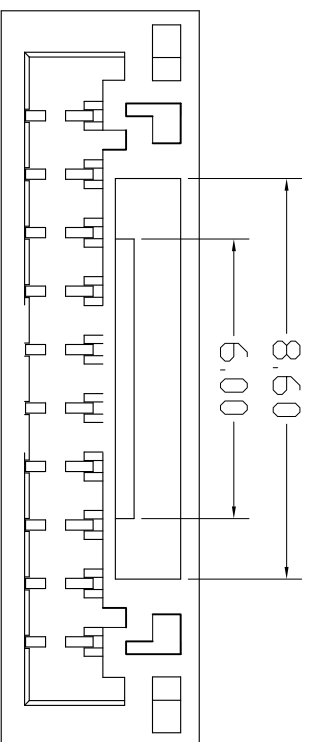

10A

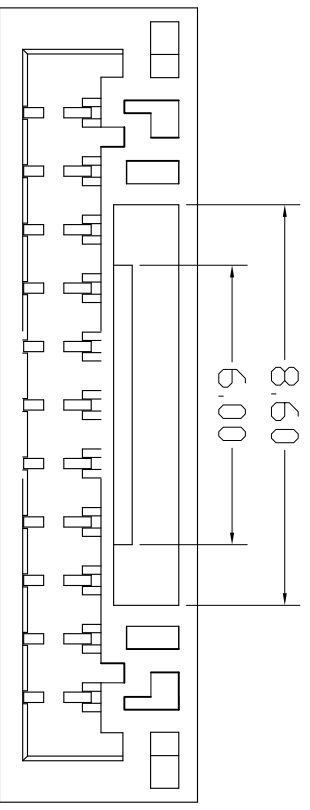

11A~15A

卧贴各P位结构示意图

GENERAL TOLERANCE		制图	张迎春	料号	A1254-nAWB	版本	A
X.±0.25	X.±2°	DRAWING	2022.08.29	PART NO.		REV.	
.X±0.20	.X±1°	审核	钱岳生	品名	GH卧贴	页次	2/2
.XX±0.15	.XX±0.5°	CHECK	2022.08.29	TITLE	WAGER SMT TYPE	SHEET	
.XXX±0.10	.XXX±0.5°	核准	张名	客户料号			
		APPROVAL	2022.08.30	CITM. NO.			
		单位	MM	比例	SCALE	1:1	
		UNITS					

乐清市宏一电子有限公司
Yueqing HongYi Electronics Co., Ltd

REV.	日期	ECN NO.	变更内容	制图
DATE	DATE	DESCRIPTION	DESCRIPTION	DRAWN

SPECIFICATIONS

- 1、Current Rating: 1A AC, DC
 - 2、Voltage Rating: 50V AC, DC
 - 3、Temperature Range: -25°C~+85°C
 - 4、Contact Resistance: 20mΩ Max
 - 5、Insulation Resistance: 100MΩ Min
 - 6、Withstanding Voltage: 500V AC/minute
 - 7、Material: Wafer PA6T/LCP, UL94V-0
- PIN Phosphoric bronze Tin-plated
Solder tad Phosphoric bronze Tin-plated

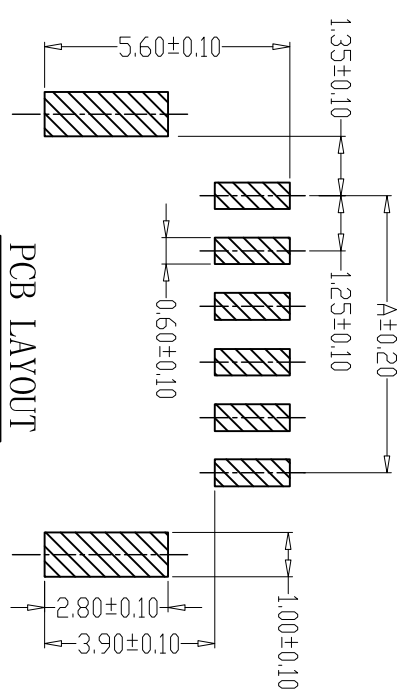
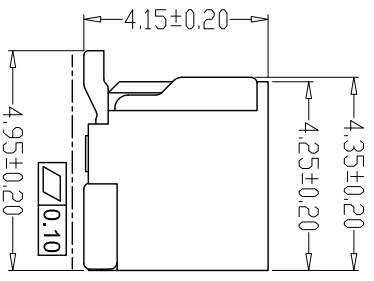
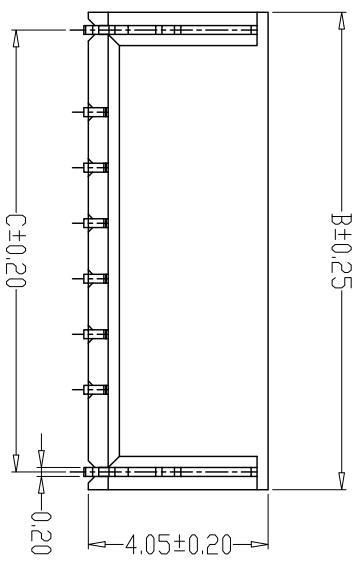
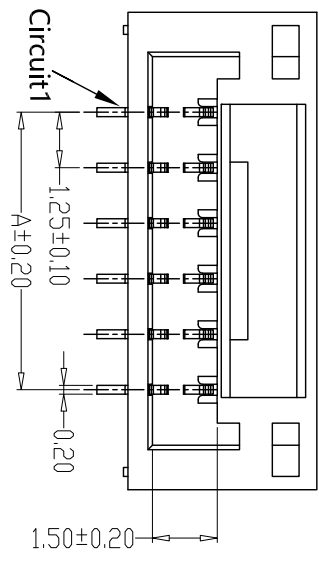

PCB LAYOUT

PIN	尺寸 (mm)		
	A	B	C
-02AB	1.25	5.75	4.95
-03AB	2.50	7.00	6.20
-04AB	3.75	8.25	7.45
-05AB	5.00	9.50	8.70
-06AB	6.25	10.75	9.95
-07AB	7.50	12.00	11.20
-08AB	8.75	13.25	12.45
-09AB	10.00	14.50	13.70
-10AB	11.25	15.75	14.95
-11AB	12.50	17.00	16.20
-12AB	13.75	18.25	17.45
-13AB	15.00	19.50	18.70
-14AB	16.25	20.75	19.95
-15AB	17.50	22.00	21.20

GENERAL TOLERANCE		制 图		料号	
X.X±0.25	X.±2°	DRAWING	张迎春	PART NO.	A12509-nAB
X.XXX±0.10		CHECK	钱岳生	品名	GH1.25立贴
X.XX±0.20		APPROVAL	张名	TITLE	WAFER SMT TYPE
		UNIT	张名	客户料号	
		SCALE	2022.08.30	CITM.NO.	
		1:1			

乐清市宏一电子有限公司
Yueqing HongYi Electronics Co., Ltd

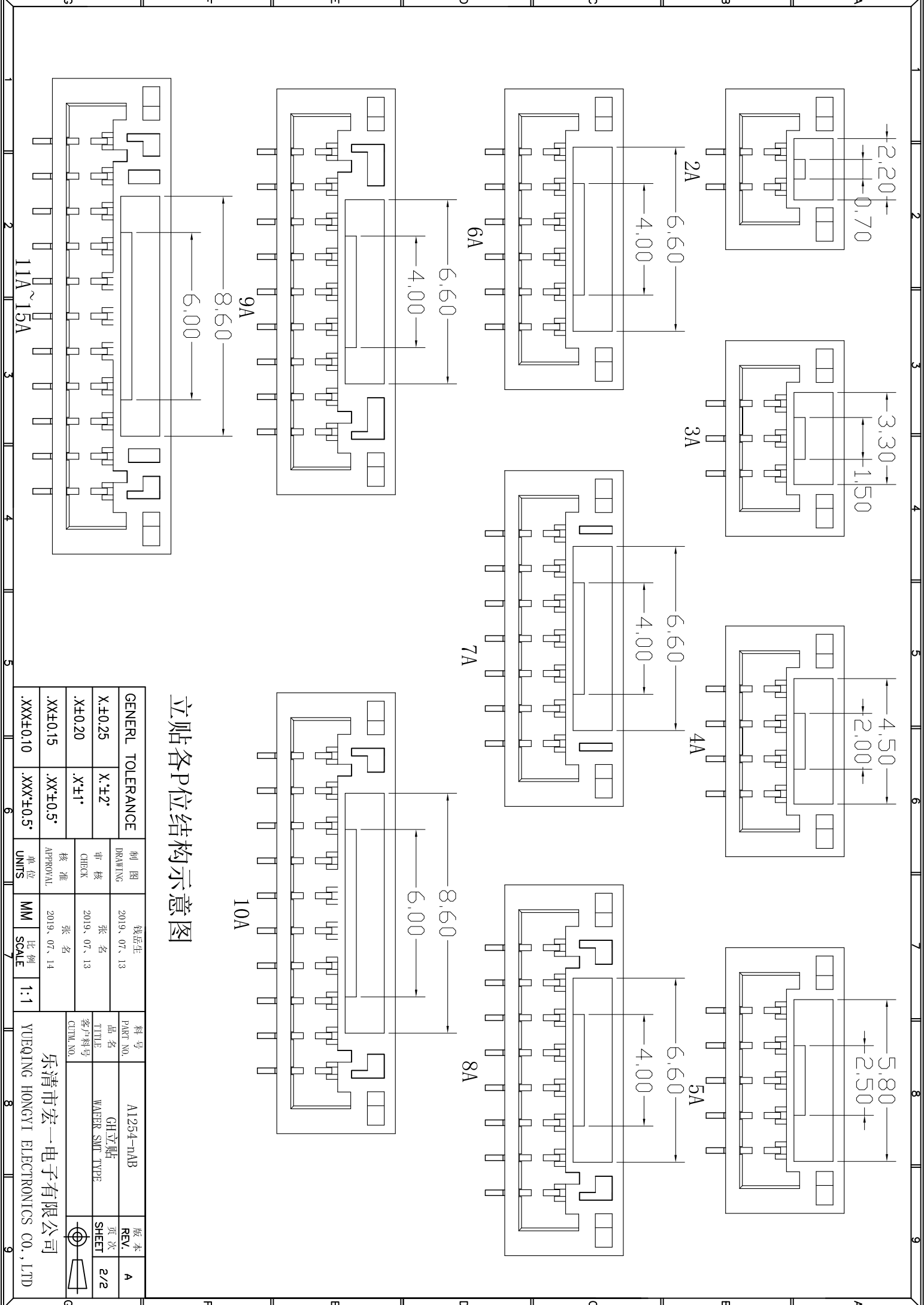

立贴各P位结构示意图

GENERAL TOLERANCE		制图		料号		版本	
X.±0.25	X.±2°	DRAWING	魏岳生	PART NO.	A1254-nAB	REV.	A
XX±0.15	XX±0.5°	CHECK	张名	TITLE	GH立贴	SHEET	2/2
XXX±0.10	XXX±0.5°	APPROVAL	张名	CUSTOMER	WASER SMT TYPE		
		UNIT	MM	SCALE	1:1	乐清市宏一电子有限公司 YUEQING HONGYI ELECTRONICS CO., LTD	